



Model: PS-D000-2S

Description:	2-Way Power Divider
Operating Frequency:	1.7 – 4.1 GHz
Insertion Loss:	0.3 dB Max
Isolation:	24 dB Min
VSWR:	Σ Port 1.20:1 Max
	Outputs 1.20:1 Max
Amplitude Balance:	± 0.1 dB Max
Phase Balance:	$\pm 0.5^\circ$ Max
Power Handling (@ SUM-Port):	Load VSWR= ∞ 2W AVG/CW Max
	Load VSWR <2:1 20W AVG/CW Max
Connectors:	SMA (f)
Impedance:	50 Ohms Nominal
Quality:	Best-Commercial-Grade

Environmental Ratings:

Temperature:	{Operating: -55°C to +95°C} & {Storage: -60°C to +110°C}
Humidity:	MIL-STD-202F, Method 103B Cond. B (96 hours at 95% R.H.)
Shock:	MIL-STD-202F, Method 213B, Cond. B (75G, 6mSec)
Vibration:	MIL-STD-202F, Method 204D, Cond. B (.06" double amplitude, or 15G)
Altitude:	MIL-STD-202F, Method 105C, Cond. B (50,000 Feet)
Temp. Shock:	MIL-STD-202F, Method 107D, Cond. A (5 cycles)

**Outline
(A = 2.600" [66.0mm])**

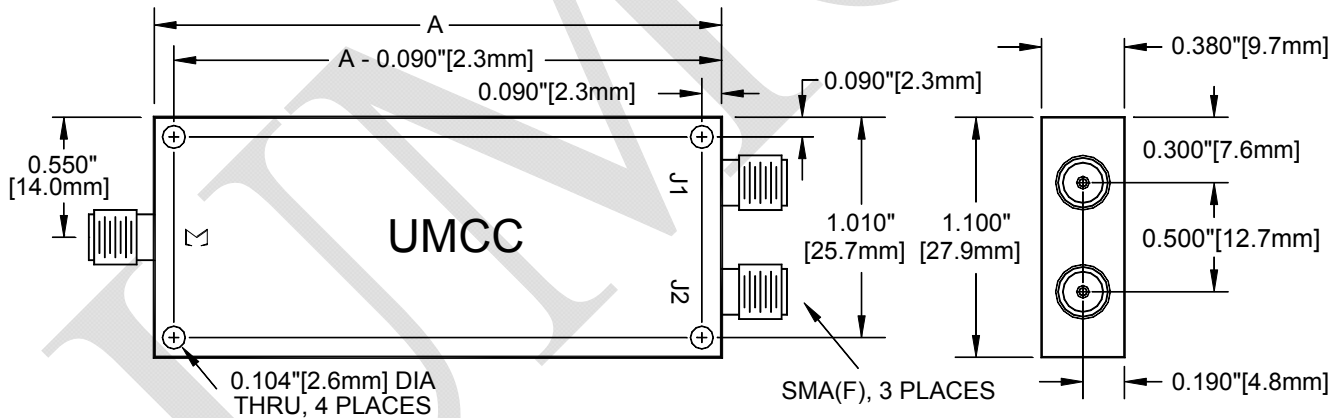

Weight
1.25 oz [35.4 g]